

UNI-T®



UT139E/S

Operating Manual



True RMS Multimeters



P/N: 110401106975X
MAY.2018 REV. 2

Table of Content

I.Introduction-----	1
II.Open box inspection-----	1
III.Safety Instructions-----	2
IV.Symbols-----	3
V.General specifications-----	3
VI.Structure-----	5
VII.LCD Display-----	6
VIII.Function dial and buttons-----	7
IX.Operation instructions-----	9
X.Technical specifications-----	20
XI.Maintenance-----	26

I. Introduction

UT139E/UT139 True RMS multimeter is a professional device designed for electrical trade.

Special features of this series are:

- A. LPF function: filtering interference signal, e.g carrier frequency interference and harmonic interference.
- B. LoZ function: measures residual 'ghost' voltage.
- C. 31 segments of stimulation bar graph: quickly observe the change of test results.
- D. UT139S with black EBTN display screen

UT139E/UT139S comply with CAT III 600V safety standard and cETLus certification.

II. Open Box Inspection

Open the package box and take out the device. Please check whether the following items are deficient or damaged and contact your supplier immediately if they are.

User manual -----	1 pcs
Test leads-----	1 pair
K-type thermocouple-----	1 pcs
Batteries: -----	2 pcs

III. Safety Instructions

Safety Standards

CE, cETLus

EN 61326-1:2013; EN 61326-2-2:2013

EN 61010-1:2010; EN 61010-2-030:2010; EN 61010-2-033:2012

Conforms to UL STD. 61010-1, 61010-2-030, 61010-2-033, Certified to CSA STD. C22.2 No. 61010-1, 61010-2-030, 61010-2-033.









CAT III 600V, double insulation standard, over voltage standard, and RoHS, pollution grade II

Safety Instructions

CAT III: It is applicable to test and measuring circuits connected to the distribution part of the building's low-voltage MAINS installation.

- 1) Do not use the device if the rear cover is not covered up or it will pose a shock hazard
- 2) Do not use the device if the device or test leads appear damaged or if you suspect that the device is not operating properly. Pay particular attention to the insulation layers.
- 3) To avoid false reading, replace the battery when the battery indicator  appears.
- 4) Functional dial should be switched to proper position.
- 5) Never input voltage and current exceeding the value listed on the device.
- 6) Do not switch the functional dial during measuring.
- 7) After each measure, disconnect the test leads with the circuit. For measuring current, switch off the power supply before test leads disconnection, especially important for measuring large current.
- 8) Use caution to measure voltage >DC 60V or AC 30Vrms.
- 9) Do not use or store the device in high temperature, high humidity, flammable, explosive or strong magnetic field environments.
- 10) Do not change the internal circuit of the device in order to avoid the damage to the device and users.
- 11) Use damp cloth to clean the case; do not use detergent containing solvents or abrasives.
- 12) Please operate the device according to this manual, or the protection may be impaired.
- 13) Replace the test lead if the insulation layer is damaged.

IV. Symbols

	Low battery
	AC/DC
	Warning
	Double insulation
	High voltage hazard
	Grounding
	Comply with European Union Standards
	cETLus Certification

V.General specifications

- 1).Max voltage between input terminal and earth grounding: See Technical Specifications
- 2).Fuse Type:
A Jack: FF 10A H 600V Fuse (Φ6x25) mm
mA/μA Jack: FF 600mA H 600V Fuse (Φ6x32) mm

- 3). Max Display Value:

Capacitance measurement: 9999

Frequency measurement: 9999

Other measurement: 5999

Duty Ratio: 0.1~99.9%

Others:

- 1).Range: Auto/Manual

- 2).Polarity: Manual

- 3).Display updates 2~3 times for every second. Overrange Indicator: "OL"

- 4).Display screen:

UT139E: TN LCD

UT139S: EBTN LCD

- 5).Operating temperature: 0°C~40°C (32°F~104°F)

Storage temperature: -10 °C~50 °C (14 °F~122 °F)

Relative humidity: ≤75% at 0 °C~30 °C; ≤50% at 30 °C~40 °C

- 6).Operating altitude: 0~2000m

- 7).Battery type: AA R6P 1.5V×2

- 8).Low power indicator:

- 9).Dimension: 175mm×81mm×48.5mm

- 10).Weight: UT139E ~354g ; UT139S~345g(with batteries)

- 11).Electromagnetic compatibility:

RF≤1V/m, overall accuracy=specified accuracy+5% of range.

RF>1V/m, no specified calculation.

VI. Structure (see figure 1)

1. Protective case
2. Display screen
- 3.4.7 Functional buttons
5. Functional dial
6. Input jacks

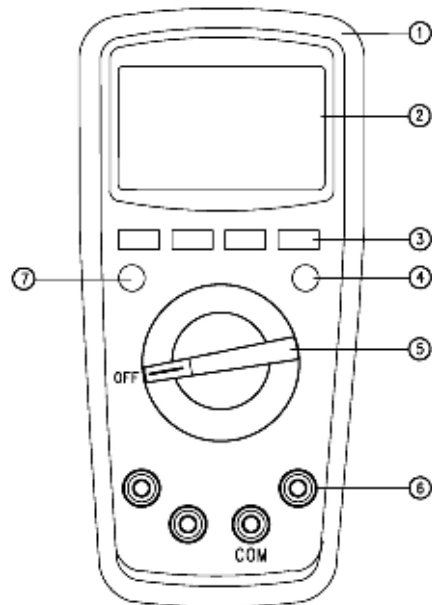
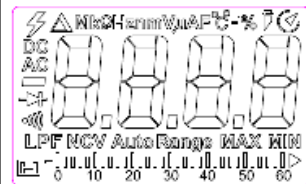

Figure1

VII. LCD display (see figure 2)



UT139E (TN LCD), UT139S (EBTN LCD)

Symbol	Note	Symbol	Note
	Warning AC voltage>30V	Hz,kHz,MHz	Unit of frequency
	Reading in hold status	%	Unit of duty ratio
-	Negative number	mV,V	Unit of voltage
AC/DC	AC or DC measurement	μA,mA,A	Unit of current
MAX/MIN	Maximum or minimum reading	nF,μF,mF	Unit of capacitance
	Low power	°C	Celsius degree
Auto Range	Auto range selection	°F	Fahrenheit degree
	Diode measurement	LPF	Low-pass filter
	Continuity measurement	NCV	Non-contact voltage
	Relative measurement		Auto shutdown
Ω, kΩ, MΩ	Unit of resistance		31 segments of bar graph

VIII.Functional dial and buttons

Position	Note
V~ V= mV≍	Voltage measurement(AC/DC)
Ω	Resistance measurement
▶	Diode measurement
•)	Continuity measurement
⊖	Capacitance measurement
Hz	Frequency measurement
%	Duty ratio measurement
°C/°F	Temperature measurement
μA≍ mA≍ A≍	AC/DC measurement
LPF	Variable frequency voltage measurement(Low pass filter)
LoZ V~	Low impedance voltage measurement
NCV	Non-contact voltage measurement
OFF	Shutdown

Buttons :

RANGE : Switch the range mode to auto/manual and then cycle through all ranges. To exit auto/manual mode, press the button for 2 seconds or switch the functional dial. (only for V~, V=, mV≍, Ω, I≍ measurement)

MAX/MIN : Starts and stops Max/Min recording. To exit this mode, press the button for 2 seconds or switch the functional dial. (only for V≍, I≍ measurement)



REL : Save the first reading as reference value. The second reading=second measurement value-reference value. To exit his mode, press the button for 2 seconds. (only for V~, V=, mV≍, I≍ measurement); when measuring capacitance, REL button is only used for eliminating intrinsic value.

Hz/% : When measuring AC voltage/ current, press the button to cycle through frequency and duty ratio measurement.

SELECT : Select functions. Under AC modes, "LPF" symbol appears, to enter variable frequency voltage measurement.

HOLD/LIGHT : Press the button once to hold the reading. Press again to unlock the reading and enter general measurement modes. Press this button for 2 seconds to turn on the backlight which will auto shutdown after 20s lightening. Or press for 2 seconds to turn off the backlight.

XI. Operation instructions

To avoid false reading, replace the battery if the battery low power symbol  appears. Also pay special attention to the warning sign  besides the test lead housing, indicating that the tested voltage or current must not exceed the values listed on the device.

1.AC/DC voltage measurement (see Figure 3)

- 1) Switch the dial to V~ or V-
- 2) Insert the red test lead to **VΩHz°C** jack, black to COM jack.
- 3) Connect test leads with the load in parallel.
- 4) Reading is displayed.

Warnings:

Do not input voltage over 600Vrms, or it may pose shock hazard.

Be cautious when measuring high voltage

Note:

Before using the device, it is suggested to measure a known voltage for verification.

After using LoZ function, please wait for 3 mins for another operation of this device.

When input impedance about 10MΩ, there is measurement errors. Input impedance ≤ 10 kΩ, measurement errors can be ignored ($\leq 0.1\%$)

At mV position, if input impedance ≥ 3 MΩ, there is higher measurement frequency. When the test leads is disconnected, there may be some digits appear. This will not influence measurement.

Under ACV mode, press SELECT button to enter LPF function to filter high frequency interference signal. (applicable for variable frequency voltage)

At Loz voltage (3kΩ) measurement, to eliminate spurious voltage, Loz mode provides with low impedance to obtain accurate readings.

Readings of AC voltage measurement are true RMS.

At AC mV position, press Hz% button to enter frequency measurement. Testing range is 10Hz~10MHz.

At other voltage measurement positions, the range is 10Hz~100kHz.

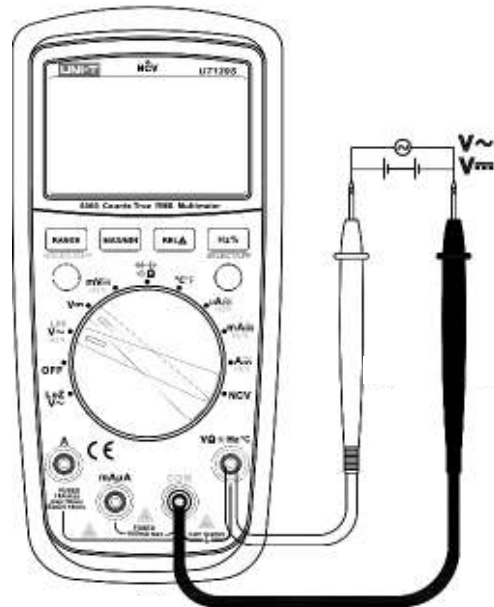

Figure 3

2. Resistance measurement. (see figure 4a)

- 1) Switch the dial to Ω .
- 2) Insert the red test lead to $V\Omega Hz C$ jack, black to COM jack.
- 3) Connect test leads with the load in parallel.
- 4) Reading is displayed.

▲ Notes:

- If the resistor is open or over the range, the "OL" symbol will be displayed on the screen.
- Before measuring resistance, switch off the power supply of the circuit, and fully discharge all capacitors.
- When measuring low resistance, the test leads will produce $0.1\Omega\sim 0.2\Omega$ measurement error. To obtain accurate measurement, short the test leads and use REL function.
- If the resistance when shorted is more than 0.5Ω , please check if test leads are loosened or damaged.
- When measuring high resistance above $60M\Omega$, it is normal to take a few seconds to steady the readings.
- Resistance measurement can be used to inspect device's internal fuses. (see figure 4b)

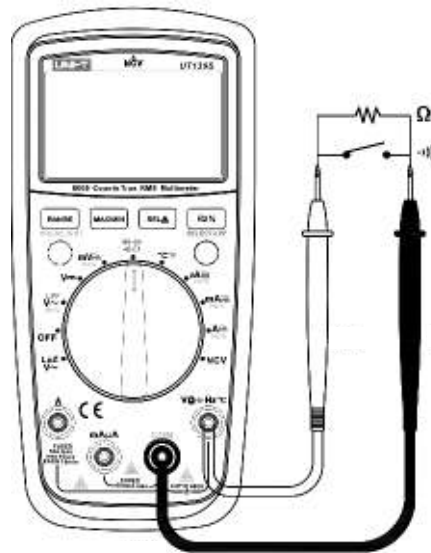

4a

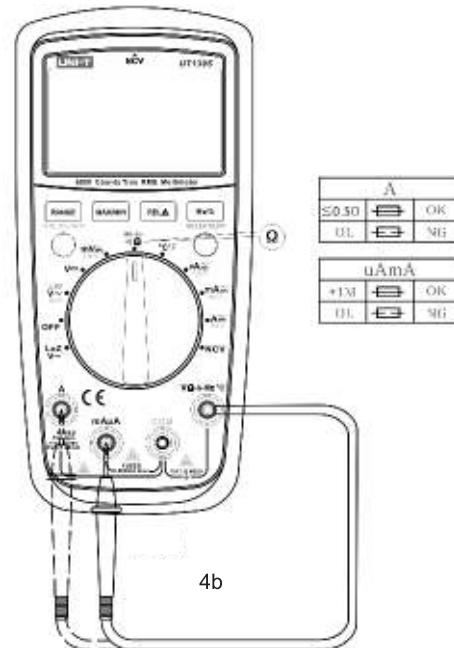

4b

3. Continuity measurement (see figure 5)

- 1) Switch the dial to $\rightarrow \cdot \cdot \cdot \Omega \leftarrow$
- 2) Press SELECT button once
- 3) Insert the red test lead to $\nabla \Omega \leftarrow \text{Hz} \cdot \text{c}$ jack, black to COM jack.
- 4) Connect test leads with the load in parallel.
- 5) Reading is displayed. Measured resistance $> 51\Omega$, circuit is in open status.
Measured resistance $\leq 10\Omega$, circuit is in good conduction status, buzzer will go off

⚠ Warnings:

- switch off the power supply to the circuit, and fully discharge all capacitors
- Do not input over 60V DC or 30V AC or it will pose shock hazard.

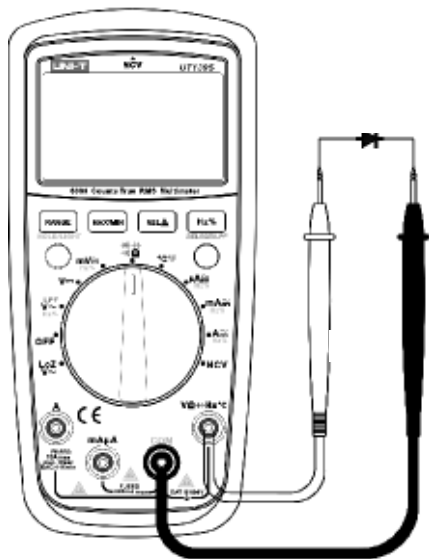

Figure 5

4. Diode measurement (see figure 5)

- 1) Switch the dial to $\rightarrow \cdot \cdot \cdot \Omega \leftarrow$
- 2) Press SELECT button twice
- 3) Insert the red test lead to $\nabla \Omega \leftarrow \text{Hz} \cdot \text{c}$ jack, black to COM jack.
- 4) Red test lead to positive pole, black to negative pole.
- 5) Reading is displayed.
- 6) "OL" symbol appears when the diode is open or polarity is reversed. For silicon PN junction, normal value: 500 ~ 800mV (0.5 ~ 0.8V).

⚠ Warnings:

- Do not input over 60V DC or 30V AC or it will pose shock hazard.

⚠ Notes:

- switch off the power supply to the circuit, and fully discharge all capacitors
- Voltage for testing diode is about 3.1 V.

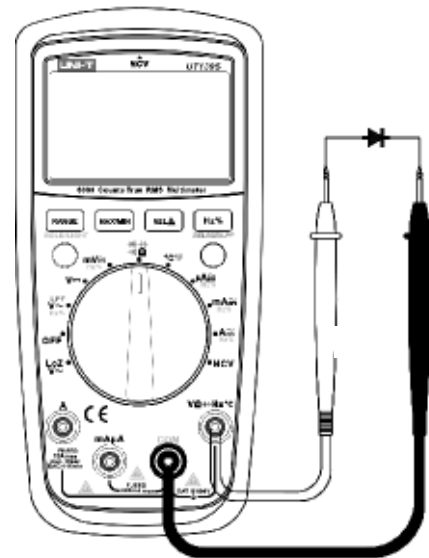

Figure 5

5. Capacitance measurement (see figure 6)

- 1) Switch the dial to $\rightarrow \Omega \leftarrow$
- 2) Press SELECT button three times
- 3) Insert the red test lead to $V\Omega Hz^{\circ}C$ jack, black to COM jack.
- 4) Reading is displayed.

⚠ Notes:

- Switch off the power supply to the circuit, and fully discharge all capacitors
- Before measuring capacitors (especially for high voltage capacitors), please fully discharge them.
- If the tested capacitor is shorted or its capacity is over the specified range "OL" symbol will be displayed on the screen.
- When measuring large capacitors, it may take a few seconds to obtain steady readings.
- When there is no input, the device displays a fixed value (intrinsic capacitance). For small capacitance measurement, to ensure measurement accuracy, the measured value must be subtracted from intrinsic capacitance. Or users can measure small capacity capacitors with relative measurement function (REL) (the device will automatically subtract the intrinsic capacitance)

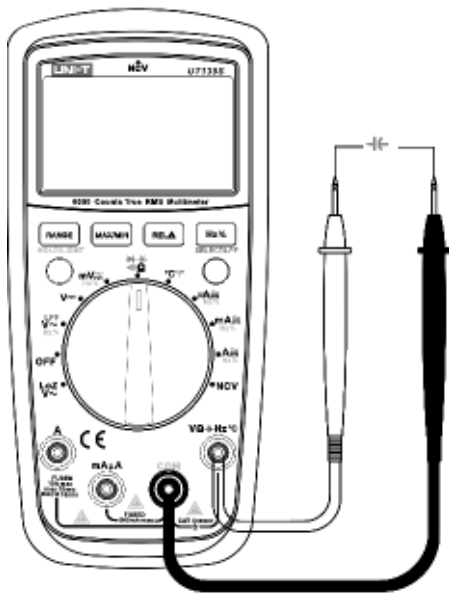

Figure 6

6. Frequency/ Duty Ratio measurement (see figure 7)

- 1) Switch the dial to mV position, under AC mode, press Hz/% button to select frequency or duty ratio measurement.
- 2) Reading is displayed.

⚠ Warnings:

Do not input over 60V DC or 30V AC or it will pose shock hazard.

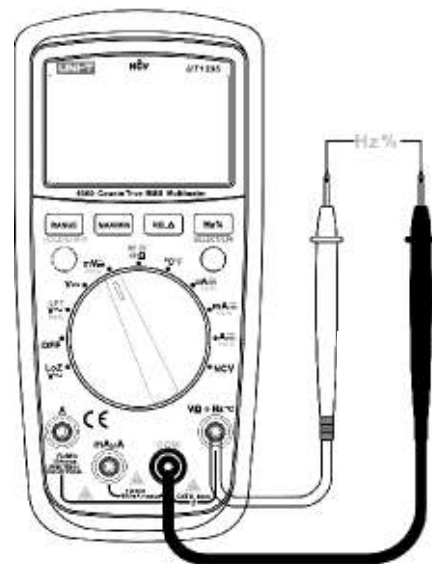

Figure 7

7. Temperature measurement (see figure 8)

- 1) Switch the dial to °C/°F
- 2) Insert K-type thermocouple to **VΩHz°C** jack (“+”end) and COM jack.
- 3) Reading is displayed.
- 4) Press SELETE to switch temperature unit.

⚠ Note:

- Only K-type thermocouple is applicable.
- The measured temperature should be less than 230°C/ 446°F ($^{\circ}\text{F} = ^{\circ}\text{C} \times 1.8 + 32$)
- Turn on the device, after “OL” symbol appears, insert K-thermocouple into the device.

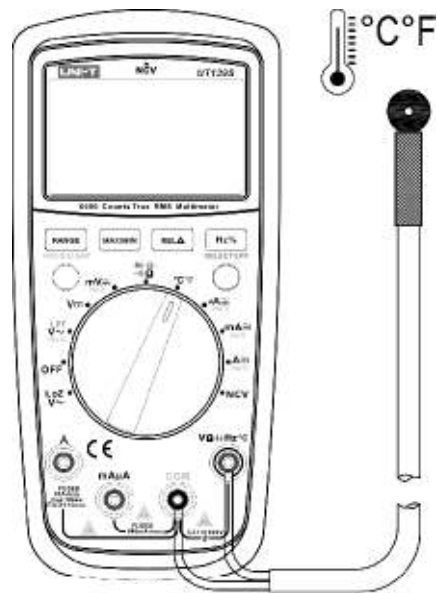

Figure 8

8. AC/DC current measurement (see figure 9)

- 1) Switch the dial to μA , mA , A
- 2) Press SELECT to switch between AC and DC current.
- 3) According to the current being measured. Insert the red test lead to A jack or $\mu\text{A}/\text{mA}$, black to COM jack.
- 4) Connect test leads with the circuit in series
- 5) Reading is displayed.

⚠ Notes:

- Before measuring, switch off the power supply of the circuit.
- If connect test leads with the circuit in series, please power off the circuit in advance.
- If the range of the measured current is unknown, select the maximum range and then accordingly reduce.
- There are fuses inside 20A jack and mA/ μA jack. Do not connect the test leads with any circuits in parallel.
- Under AC mode, readings are true RMS.
- If the tested current is 10A~20A, each measurement time is about 10 seconds (less than 30s) and the next test should be after 15 minutes.
- When measuring AC current, press Hz/% button to display AC frequency or duty ratio.

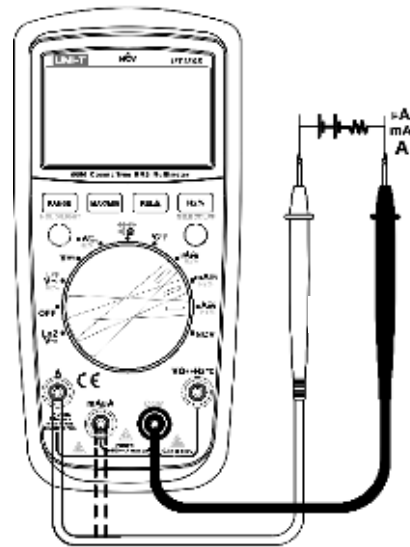

Figure 9

9. NCV measurement (see figure 10)

- 1) Switch the dial to NCV position
- 2) Place the device near the measured object. “-” symbol indicates the intensity of the electric field. More “-” and the higher the buzzer frequency, the higher the electric field intensity.
- 3) Intensity of electric field.



Figure 10

- * "EF": 0 ~ 50mV
- * "-": 50 ~ 100mV
- * "--": 100 ~ 150mV
- * "---": 150 ~ 200mV
- * "----": > 200mV

X. Others:

- The device enters measurement status in 2 seconds after startup. Restart the device is "ErrE" appears.
- The device automatically shuts down if there is no operation for 15 minutes. You can wake up the device by pressing any key.
To disable auto shutdown, switch the dial to OFF position, long press SELETE button and turn on the device.
☑ symbol will disappear with one long beep. Recover the auto-off function by restarting the device.

Buzzer notification

- 1) Input voltage $\geq 600V$ (AC /DC), buzzer will continuously beep indicating measure range is at limit
 - 2) Input current > 10A (AC/DC), buzzer will continuously beep indicating measure range is at limit
- Low power warnings:
Voltage of the battery < 2.6V, 🔋 symbol appears

XI. Technical specifications

Accuracy: \pm (% of reading + numerical value in least significant digit slot), 1 Year Warranty

Ambient temperature: $23^{\circ}C \pm 5^{\circ}C$ ($73.4^{\circ}F \pm 9^{\circ}F$)

Ambient humidity: $\leq 75\%$ RH

⚠ Notes:

- To ensure accuracy, operating temperature should be within $18^{\circ}C \sim 28^{\circ}C$.
Temperature Coefficient= $0.1 * (\text{specified accuracy}) / ^{\circ}C$ ($< 18^{\circ}C$ or $> 28^{\circ}C$)

1. DC voltage

Range	Resolution	Accuracy
UT139E/UT139S		
60.00mV*	0.01mV	$\pm (0.7\% + 3)$
600.0mV**	0.1mV	$\pm (0.5\% + 2)$
6.000V	0.001V	$\pm (0.7\% + 3)$
60.00V	0.01V	
600.0V	0.1V	

⚠ Input impedance: *mV mode: $\geq 3M\Omega$, *other mode: about $10M\Omega$.

Results might be unstable at mV range when no load is connected. The value becomes stable once the load is connected. Least significant digit $\leq \pm 3$

Max input voltage: $\pm 600V$, when the voltage $\geq 600V$, "OL" symbol appears and the buzzer goes off."

2. AC voltage

Range	Resolution	Accuracy
UT139E/UT139S		
60.00mV	0.01mV	± (1.0%+3)
600.0mV	0.1mV	
6.000V	0.001V	± (0.8%+3)
60.00V	0.01V	
600.0V	0.1V	
LPF 600.0V	0.1V	± (4.0%+3)
LoZ 600.0V	0.1V	± (2.0%+10)

⚠ Input impedance: about 10MΩ

* Display sine wave true RMS. Frequency response: 45Hz ~400Hz

* Accuracy guarantee range: 5 -100% of the range, shorted circuit allows least significant digit ≤10

* crest factor at Max range=3.0 (excluding 600V range, crest factor=1.5)

Non-sinusoidal waveform : crest factor=1.0~2.0 additional accuracy: 3.0%

Non-sinusoidal waveform: 2.0~2.5 additional accuracy: 5.0%

Non-sinusoidal waveform: 2.5~3.0 additional accuracy: 7.0%

Max input voltage: 600Vrms. ≥600V buzzer goes off, >620V "OL" symbol appears.

3. Resistance measurement.



Range	Resolution	Accuracy
UT139E/UT139S		
600.0Ω*	0.1Ω	± (1.0%+2)
6.000kΩ	0.001kΩ	± (0.8%+2)
60.00kΩ	0.01kΩ	
600.0kΩ	0.1kΩ	
6.000MΩ	0.001MΩ	± (1.2%+3)
60.00MΩ	0.01MΩ	± (1.5%+5)

⚠ Measurement result = reading of resistor – reading of shorted test leads

Open circuit voltage=1V (Current=0.4mA)

Overload protection: 600V-PTC

4. Continuity, Diode

Position	Resolution	Remark
	0.1Ω	Set Value: Open circuit: resistance ≥50Ω, no beep. Well-connected circuit: resistance ≤10Ω, continuous beeps.
	0.001V	Open circuit voltage :3.2v , test current: about 1.7mA Silicon PN junction voltage: 0.5 ~ 0.8V.

⚠ Overload protection: 600V-PTC

5. Capacitance

Range	Resolution	Accuracy
9.999nF	0.001nF	REL mode : $\pm(4\%+10)$
99.99nF ~ 999.9 μ F	0.01nF ~ 0.1 μ F	$\pm(4\%+5)$
9.999mF ~ 99.99mF	0.001mF ~ 0.01mF	$\pm 10\%$

⚠ Overload protection: 600V-PTC
Test capacitance ≤ 100 nF, adapt REL mode.

6. Frequency/Duty ratio (ACmV position)

Range	Resolution	Accuracy
9.999Hz ~ 9.999MHz	0.001Hz ~ 0.001MHz	$\pm(0.1\%+4)$
0.1% ~ 99.9%	0.1%	Only for reference

⚠ Overload protection: 600V-PTC
Input range: (DC level=0)
 ≤ 100 kHz: 100 mVrms $\leq a \leq 20$ Vrms
>100kHz~1MHz: 200 mVrms $\leq a \leq 20$ Vrms
>1MHz: 500 mVrms $\leq a \leq 20$ Vrms
>5MHz~10MHz: 1 Vrms $\leq a \leq 20$ Vrms
Duty ratio% : only for frequency ≤ 10 kHz

Notes : *when measuring AC voltage or current, following conditions should be satisfied:

Frequency response ≤ 1 kHz

AC voltage: mV position ≥ 100 mVrms; V position \geq Range $\times 6\%$

AC current: input range 'a'

4000/6000 μ A, 400/600mA, 10A: A \geq range $\times 10\%$

400/600 μ A, 40/60mA, 4/6A: A \geq range $\times 60\%$

7. Temperature

Range		Resolution	Accuracy
°C	-40~1000°C	-40~40°C	± 4
		>40~500°C	$\pm(1.0\%+4)$
		>500~1000°C	$\pm(2.0\%+4)$
°F	-40~1832°F	-40~104°F	± 5
		>104~932°F	$\pm(1.5\%+5)$
		>932~1832°F	$\pm(2.5\%+5)$

⚠ Overload protection: 600V-PTC

K-type thermocouple is only applicable for temperature less than 250°C/482°F.

8. DC current

	Range	Resolution	Accuracy
μ A	600.0 μ A	0.1 μ A	$\pm(0.7\%+2)$
	6000 μ A	1 μ A	
mA	60.00mA	0.01mA	
	600.0mA	0.1mA	
A	6.000A	0.001A	$\pm(1.0\%+3)$
	10.00A	0.01A	

⚠ Overload protection:

μ A mA range: F1Fuse ($\phi 6 \times 32$)mm FF 600mA H 600V

10 A range: F2Fuse ($\phi 6 \times 25$)mm FF 10A H 600V

Input current ≥ 19 A, buzzer goes off; input current > 20.10A "OL" symbol appears

9. AC current

	Range	Resolution	Accuracy
μA	600.0μA	0.1μA	±(1.0+3)
	6000μA	1μA	
mA	60.00mA	0.01mA	
	600.0mA	0.1mA	
A	6.000A	0.001A	± (1.2%+3)
	10.00A	0.01A	

Frequency response: 45~400Hz

Display: true RMS

Accuracy guarantee range: 5 -100% of the range, shorted circuit allows least significant digit ≤2

Input current ≥19A, buzzer goes off; input current >20.10A "OL" symbol appears

*crest factor can reach up to 3.0 at Max range

Non-sinusoidal waveform: Crest factor=1.0~2.0 additional accuracy: 3.0%

Non-sinusoidal waveform: 2.0~2.5 additional accuracy: 5.0%

Non-sinusoidal waveform: 2.5~3.0 additional accuracy: 7.0%

⚠ Overload protection: (similar to DC current)

XII. Maintenance

⚠ Warning: Before opening the rear cover, switch off the power supply (remove test leads from the input terminal and the circuit).

1. General maintenance

- 1) Clean the case with a damp cloth and detergent.
Do not use abrasives or solvents
- 2) If there is any malfunction, stop using the device and send it to maintenance.
- 3) The maintenance and service must be implemented by qualified professionals or designated departments.

2. Replacements (see Figure 11)

Battery replacement:

To avoid false reading, replace the battery when the battery indicator  appears.

Battery Specification: AA 1.5Vx2

- 1) Switch the dial to "OFF" position and remove the test leads from the input terminal.
- 2) Take off the protective case. Loosen the screw on battery cover; remove the cover to replace the battery. Please identify the positive and negative pole.

Fuse replacement:

- 1) Switch the dial to "OFF" position and remove the test leads from the input terminal
 - 2) Loosen the both screws on the rear cover, and then remove the rear cover to replace the fuse
- Fuse specification** : F1 Fuse φ6×32mm FF600mA H 600V ; F2 Fuse φ6×25mm FF 10A H 600V

Test Leads replacement: If insulation on test leads is damaged, replace it.

WARNING: Use meet EN 61010-031 standard, rated CAT III 600V, 10A or better test leads.

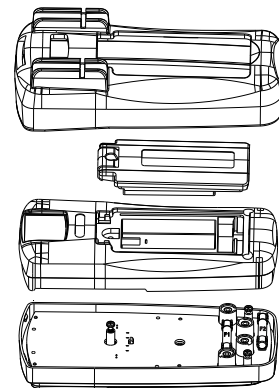

Figure 11

Uni-Trend reserves the right to update the content of this manual without further notice

UNI-T®**UNI-TREND TECHNOLOGY (CHINA) CO., LTD.**

No6, Gong Ye Bei 1st Road,
Songshan Lake National High-Tech Industrial
Development Zone, Dongguan City,
Guangdong Province, China
Tel: (86-769) 8572 3888
<http://www.uni-trend.com>