

UNI-T®



UT572

Operating Manual



Advanced Earth Resistance Tester



P/N:110401104516X
DATE:2018.06.26
REV.1

Contents

| | |
|--|----|
| I. Safety instruction----- | 1 |
| II. Product characteristics----- | 4 |
| III. Technical specification----- | 5 |
| IV. Instrument appearance and accessories----- | 9 |
| V. Preparation prior to test----- | 11 |
| VI. Test specification----- | 13 |
| VII. Storing, clearing and viewing data----- | 21 |
| VIII. Battery replacement----- | 22 |
| IX. Maintenance and repair----- | 22 |



I. Safety instruction

The operation instruction includes the precautions and safety rules to be preserved to ensure the safety usage of instrument. Please read the instructions carefully prior to use and know well the operation methods.

Note:

1. Please read and understand the contents described in the operation instruction prior to use the instrument.
2. The operation instrument shall be preserved well for future use.
3. The instrument shall be tested in strict compliance with the testing methods specified in the operation instruction.
4. Familiarizing the safety-relating contents in the operation instrument shall be required.
5. Observe following safety rules strictly, or otherwise the possible accident or instrument damage will occur.

The safety symbol “” herein contains three meanings to which special attention must be paid by the user.

| | |
|---|---|
|  | anger- misoperation will possibly cause severe or fatal injury. |
|  | Warning- misoperation will cause severe or fatal injury. |
|  | Notice- misoperation will cause slight injury or instrument damage. |

Danger

- Never use the instrument in the loop with ground voltage above AC/DC300V.
- Never test in the flammable and explosive environment, or the possible spark will cause explosion.
- Never conduct wiring operation when the instrument or your hands are damp.
- Never apply on the instruent the power exceeding its allowable limit or the testing range.
- Never open the battery cover while testing.





Warning

- Never conduct testing under abnormal condition such as rupture of gluey shell and exposure of metal wire, etc.
- Never change the testing range (gear change) if the testing pin is connected during testing.
- Never dismantle the instrument arbrarily. Contact with our after-sale service department in case of any requirment for repair.
- Never replace the battery or open the battery cover when the instrument surface is wet. Drying is required before any operation.
- Never replace the battery or open the battery cover unless the instrument has been shut down.

 Notice

- Prior to testing , please confirm the connecting plugs of testing wire have been inserted in the corresponding ports.
- Take out and preserve well the battery if does not use this instrument for long time.
- Never expose the instrument to the severe environment with extreme temperature and humidity.
- Always clean the instrument with dry cloth or neutra cleaning agent instead of grinding compound or solvent.
- The wet instrument must be dried before preservation.

The instrument has following graphical signs and the meaning of which are described below:

| | |
|---|--|
|  | Means the danger, warning and notice signs. |
|  | Means the double insulation or reinforced insulation protection. |
|  | CE compliance EU standard |
|  | Low battery |

II. Product characteristics

The instrument is controlled by intelligent micro-control chip, providing high precision and reliability; applicable to measuring the ground resistance value of various grounding devices such as the power facility wiring, electrical equipments and lightning proof devices (note: the instrument is not applicable to applications under severe outdoor environment conditions, like raining, lightning, etc.)

1. The 2, 3 and 4 wire testing and soil resistivity (ρ).
2. Test the signal frequency: 94Hz /128Hz is available.
3. Compensating resistance RK testing can be conducted.
4. Disturbance voltage Ust and disturbing frequency Fst testing can be conducted.
5. The distance setting range for soil resistivity (ρ): 1-40m.
6. Auxiliary grounding resistance RH and RS testing can be conducted.
7. Ust overlarge alarm function: the instrument is not allowed to perform testing when the disturbing voltage is excessively high.
8. Data storage function.
9. Battery detection and backlight function.
10. Automatic power-off function: press the button to select no-action in the state of power-on, and the instrument will automatically shut down to save power about 5min later.
11. Double insulation or reinforced insulation safety structure.

III. Technical specification

1. Testing range and testing error (when 20±5°C and ≤75%R)

| Function | Measurement Range/Testing Range | Resolution | Accuracy |
|-----------------------------|---------------------------------|------------|----------------------------------|
| Grounding resistance (Re) | 4Ω | 0.01Ω | ±(3%+15) Note ① |
| | 40Ω | 0.1Ω | ±(3%+5) Note ① |
| | 400Ω | 1Ω | |
| | 4KΩ | 0.01KΩ | |
| 4-wire testing | 40KΩ | 0.1KΩ | |
| Soil resistivity (ρ) | 4Ω | | ρ=2×π×L×Re Note ② |
| | 40Ω | | |
| | 400Ω | | |
| | 4KΩ | | |
| | 40KΩ | | |
| Disturbance voltage (Ust) | 1- 50V | 1V | ±(3%+3) Note ③ (DCV/40~500Hz) |
| Disturbance frequency (Fst) | 40~500Hz | 1Hz | ±(1%+2) |

Note: ① the auxiliary grounding resistance is 100Ω, a data after rectified Rk.

Note: ② accuracy depends on the testing value of Re; the space (L) between auxiliary grounding pins is 1-40m.

Note: ③ the maximum testing range for disturbance voltage (Ust) is 50Vrms, therefore the instrument is not applicable to the mains voltage testing.

Note: ④ the testing value for auxiliary grounding resistance RH and RS is for reference only.

When the grounding resistance RH/RS is not 100Ω (and less than the maximum limit value), the testing accuracy of grounding resistance Re should be as follows:

| Function | Gear/Measurement range | Resolution | Maximum limit value of RH/RS | Accuracy |
|---------------------------|------------------------|------------|------------------------------|----------|
| Grounding resistance (Re) | 4Ω | 0.01Ω | 1kΩ | ±(5%+10) |
| | 40Ω | 0.1Ω | 4kΩ | |
| | 400Ω | 1Ω | 40kΩ | |
| | 4KΩ | 0.01kΩ | 50kΩ | |
| 4-wire testing | 40KΩ | 0.1kΩ | 50kΩ | |

Note: the testing accuracy of soil resistivity (ρ) depends on the testing value of Re.

2. Application standard:

EN 61010 -1 CAT III 300V Pollution Grade II

EN 61010 -2-033

EN 61010-031

3. Maximum testing range:

Grounding resistance: 40KΩ

Soil resistivity: 1000KΩm

Series interference voltage: 50V

4. Working environment:

Temperature: 0°C- 40°C

Relative humidity: ≤80%RH (fogless)

Elevation: ≤2000m

5. Storage condition:

Temperature: -20°C-60°C

Relative humidity: ≤75%RH (fogless)

6. Power supply: AA alkaline battery (1.5V) ×8

7. Overload protection: E-S, E-H, among each terminal, AC220V/10s

8. Insulation impedance: (1000V circuit to housing) ≥50MΩ

9. Withstand voltage: between circuit and housing, AC 3540V(50/60Hz)/5s, no jump-spark

10. Overall dimensions: 210mm x175mmx90mm

11. Weight: about 1,100g

12. Accessories:

| | |
|--|---|
| Green testing wire, 5m----- | 1 |
| Yellow testing wire, 10m----- | 1 |
| Red testing wire, 20m----- | 1 |
| Black testing wire, 20m----- | 1 |
| Red testing wire, 40m----- | 1 |
| Long pin for grounding test----- | 4 |
| Simple testing wire with alligator clip----- | 1 |
| AA alkaline battery ----- | 8 |
| Operation instruction----- | 1 |
| Tool box/braces/cloth bag----- | 1 |

IV. Appearance and accessories

1. LCD screen;
2. Display/menu key;
3. UP/RK key;
4. Backlight/Confirmation key;
5. DOWN/Storage key
6. Testing key;
7. Function selection key;
8. Grounding terminal E;
9. Grounding detection terminal ES;
10. Auxiliary grounding terminal H and S.

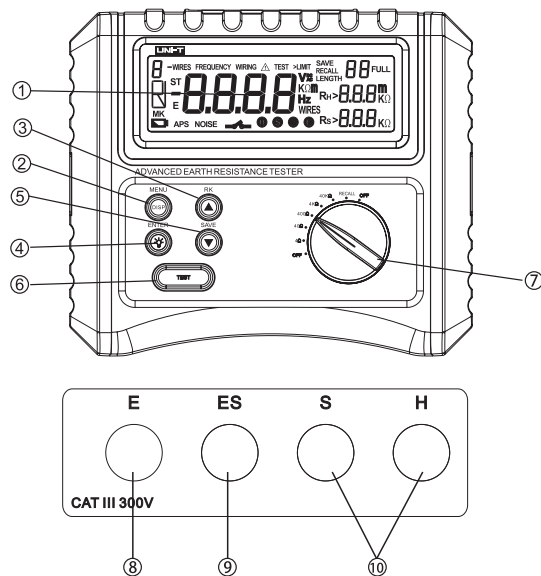

Testing accessories are shown below:

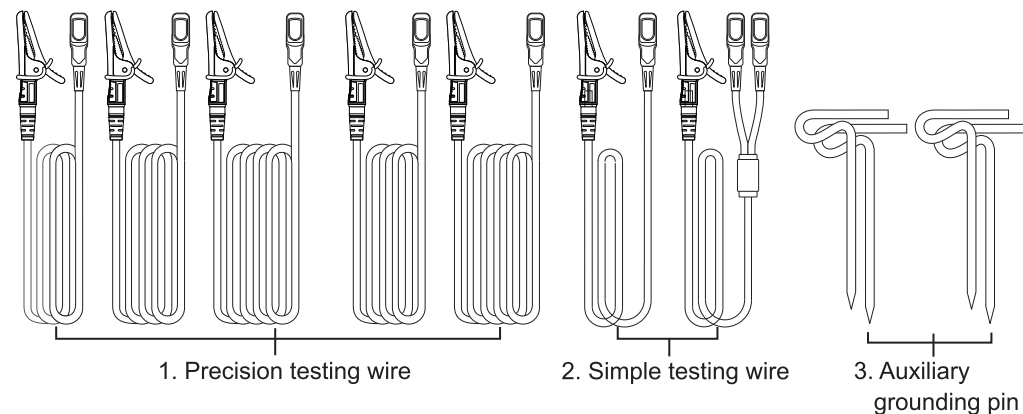

1. Precision testing wire



2. Simple testing wire

3. Auxiliary grounding pin

V. Preparations prior to testing

1. Battery voltage check:

Prior to starting up the instrument, if LCD displays the battery symbol “”, it means the battery is in low battery condition (about less than 9.5V), it is required to replace the battery immediately or the instrument will not work normally.

Note: the instrument is not allowed to perform testing when LCD displays “” during the standby state of instrument; if LCD displays the low battery symbol “” during testing, it is also required to replace the battery or otherwise the instrument will not work normally.

2. Set the testing condition

After starting up the instrument, set the function selection switch at any one gear like the 4Ω/40Ω/400Ω/4KΩ/40KΩ. LCD will enter MENU setting screen after about 2s long press on “MENU” key; the default is the testing mode (wire number) setting state: 3-wire, at this time, “3” will flash; by using the key “▲” or “▼”, you can select 2-wire, 3-wire, 4-wire and soil resistivity (ρ -WIRE) mode after pressing “ENTER”; After this operation, the instrument will enter the testing signal frequency (FW) setting screen; you can also select the frequency: 128Hz or 94Hz by using the key “▲” or “▼” after pressing “ENTER”. If the previously selected testing mode (wire number) is soil resistivity (ρ -WIRE) mode, the instrument will enter the screen of setting spacing distance between auxiliary grounding pins, with default value (LENGTH) of 20m. The distance range, about 1-40m, may be regulated by using “▲” or “▼”, and after pressing “ENTER”, the setting screen will jump to the testing mode (wire number) setting state; if the previous selected testing mode

(wire number) is not the soil resistivity (ρ -WIRE) mode, there will be no setting of the spacing distance between auxiliary grounding pins. After setting, after another 2s long press on “MENU”, the instrument will exit the setting screen and enter RE testing state screen.

3. Testing of compensation resistance (RK)

Allow the function selection switch at 4Ω gear, then the testing mode (wire number) is 2-WIRE or 3-WIRE or 4-WIRE, after 2s long press on “RK”, the instrument enters RK testing state; clamp the testing wire alligator clips (short connection), press “TEST” to test and after testing, press “ENTER” to confirm, and then exit RK testing state and enter RE testing state screen. When the testing value exceeds 4Ω, press “ENTER” to confirm, check the testing wire for breakage or the plug for poor contact.

Note: the RK testing cannot be conducted under soil resistivity (ρ -WIRE) mode.

4. Backlight function

With short press on “”, backlight is turned on; after another short press, it is turned off.

5. Automatic shutdown

The instrument will automatically shut down to save power 5min later if no any key pressing or operation of function selection switch under the standby state.

6. Disturbance voltage (grounding voltage) testing function

While testing the grounding resistance (RE) and soil resistivity (ρ), the instrument will automatically detect the size of disturbance voltage (UST) and disturbance frequency (FST). When the disturbance voltage > 50V, LCD displays “OL V”, indicating the testing value is overranging. Please turn off the relevant electric equipments before any grounding resistance or soil resistivity testing when the disturbance resistance > 10V.

7. Auxiliary grounding resistance (RH and RS) testing function

The instrument can be used to test the auxiliary grounding resistance (RH and RS). Please check the testing wire for connection when the RH value or RS testing value is too large.

Note: Excessive high RH or RS testing value will affect the testing accuracy of grounding resistance RE and soil resistivity (ρ).

8. Connection of precision testing wire and simple testing wire

The precision and simple testing wire should be individually inserted in the corresponding port of instrument completely, and the poor or improper connection will cause testing error.

Note: if the key TEST is pressed when the testing wire has not yet connected, in the range above 400Ω , display screen will display other numbers other than OL, which does not mean the existence of fault.

VI. Test specification

Never apply voltage between the testing ports of instrument while performing the grounding resistance or soil resistivity testing.

1. Precision (3-wire) testing:

The method is the general testing method for grounding resistance. The port to be used: E, S and H port.

Testing wire: corresponding to E, S and H port respectively. Auxiliary grounding pin: 2

(1) Setting the testing mode (wire number)

Please set the 3-WIRE by referring to "Testing condition setting 2".

(2) Rk setting

① Allow three testing wires (green, yellow and red) to be inserted to the corresponding ports of instrument respectively.

② Select the range of 4Ω .

③ Allow the alligator clips of three testing wires to be short circuited.

④ Refer to the testing of compensation resistance (Rk) in 5.3.

Note: if "Rk=OL Ω " is also displayed after shorting-circuiting three testing wires, there would be testing wire breakage or poor contact.

(3) Use and wiring of auxiliary grounding pin
Place and deeply drive the auxiliary grounding pin corresponding to port S and H into the ground in a straight line, with a spacing distance of about 5-10m to the grounding body to be measured. Connect the port E, S and H of instrument to the grounding body to be measured, auxiliary grounding pin S and H respectively by using the testing wires (green, yellow and red). (See Figure 3)

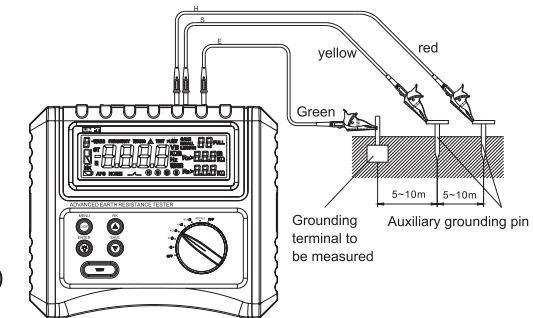

Figure 3

(4) Testing of grounding resistance

After wiring, select any one of the range and perform testing by pressing TEST.

Note: excessive high auxiliary grounding resistance (RH/RS) will affect the testing accuracy. Please check if the testing wire is poorly contacted.

If it is required to test in a dry or small pebble coated place and the sand, maintain the place or the and fully wet by sprinkling water at the place where the auxiliary grounding pin is driven. While performing testing on the concrete ground, it can be conducted by soaking the levelly-placed auxiliary grounding pin or binding the pin with wet cloth.

Stop testing when the disturbance voltage is quite high (greater than 10V). Please turn off relevant electrical equipments prior to any testing.

2. Precision (4-wire) testing:

It is a testing method with higher accuracy. The port to be used: E, ES, S and H port.

Testing wire: corresponding to E, ES, S and H port respectively. Auxiliary grounding pin: 2

(1) Setting the testing mode (wire number)

Please set the 4-WIRE by referring to "Testing condition setting 2".

(2) Rk setting

- ① Allow 4 testing wires (green, black, yellow and red) to be inserted to the corresponding ports of instrument respectively.
- ② Select the range of 4Ω .
- ③ Allow the alligator clips of 4 testing wires to be short circuited.
- ④ Refer to the testing of compensation resistance (Rk) in 5.3.

(3) Use and wiring of auxiliary grounding pin

Place and deeply drive the auxiliary grounding pin corresponding to port S and H into the ground in a straight line, with a spacing distance of about 5-10m between pins from the grounding body to be measured. Connect the port E, ES, S and H of instrument to the grounding body E to be measured, auxiliary grounding pin ES, auxiliary grounding pin S and to the auxiliary grounding pin H respectively by using the testing wires (green, black, yellow and red). The black wire for ES port and the green wire for port E is connected to the same grounding body to be measured (See Figure 4).

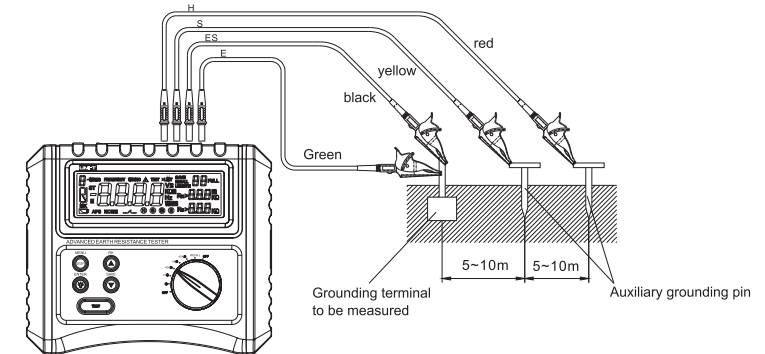

Figure 4

(4) Testing of grounding resistance

After wiring, select any range and press TEST.

Display screen displays the grounding resistance R_e value.

The operation is similar to that of 3-wire testing.

3. Simple (2-wire) testing:

Danger:

The instrument cannot be used to test the voltage of commercial power supply since it is not designed for the commercial power.

Conduct testing by the 2-port method by taking the grounding electrode of known minimum grounding resistance as the auxiliary grounding electrode. In addition, the available electrode may be the metal embedded components like metal pipeline, the common grounding of commercial voltage or the building and the type A grounding electrode (such as lightning rod).

Port to be used: port E, S and H.

Testing wire: simple testing wire.

Auxiliary ground rod: no.

(1) Set the testing method (wire number)

Please set 2-wire by referring to “5.2 testing condition setting”.

(2) R_k setting

- ① Allow simple testing wires to be inserted to the corresponding ports of instrument respectively.
- ② Select the range of 4Ω .

③ Allow the alligator clips of 4 testing wires to be short circuited.

④ Refer to the testing of compensation resistance (R_k) in 5.3.

Note: if “ $R_k=OL\Omega$ ” is also displayed after shorting-circuiting the simple testing wires, there would be testing wire breakage or poor contact.

(3)Wiring

Perform wiring as per Figure 5.

Note: Port S and H must be short-circuited if the attached simple testing wire is not used.

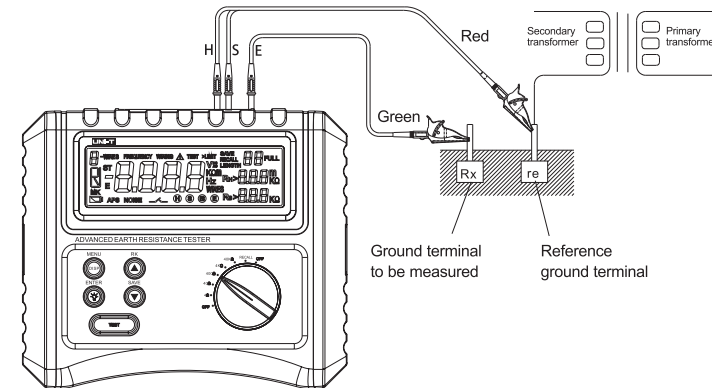

Figure 5

(4) Testing of grounding resistance

After wiring, select the high resistance range as much as possible, press TEST. After testing, LCD displays the grounding resistance R_e value. Switch to the next range for a more accurate testing if the grounding resistance is too low.

4. Testing of soil resistivity (ρ)

Determine the spacing distance between auxiliary grounding pins, and test the soil resistivity after driving 4 auxiliary ground rods in the earth with the same spacing distance.

Port to be used: E, ES, S and H. Testing wire: corresponding to port E, ES, S and H. Auxiliary grounding pin: 4

(1) Setting the testing mode (wire number)

Set ρ -wire by referring to “5.2 testing condition setting”.

Note: it is unable to set R_k when testing the soil resistivity (ρ).

(2) Driving and wiring of auxiliary grounding pin

Drive 4 auxiliary grounding pins in the earth in a straight line with spacing distance of 1-40m. Then, the driving depth should be set as the value less than 5% of spacing distance between auxiliary grounding pins. (for example, when the spacing distance between auxiliary grounding pins is 5m, the driving depth should be 25cm). Excessive driving depth would cause testing value error of soil resistivity.

Note: the attached auxiliary grounding pin has a length of 20cm.

Drive in the auxiliary grounding pin, and connect the port E, ES, S and H to the auxiliary grounding pin respectively by using testing wire (20m red wire 10m yellow wire, 20m black wire and 40m red wire). (See Figure 6).

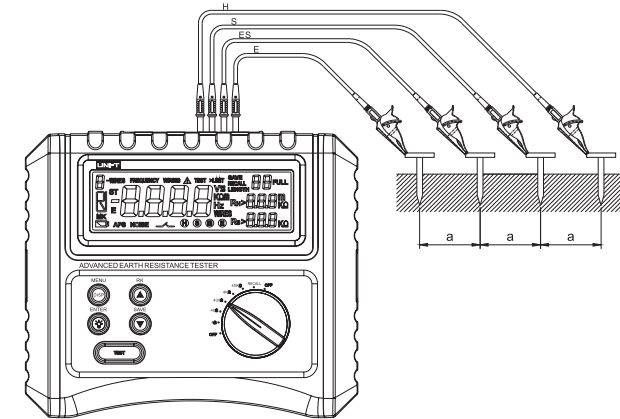

Figure 6

(3) Set the spacing distance between auxiliary grounding pins

By referring to “5.2 testing condition setting” and the LENGTH setting for auxiliary grounding pin during testing soil resistivity (ρ), set the spacing distance between grounding pins.

(4) Testing of soil resistivity (ρ)

After wiring, select any range, press TEST. After testing, LCD displays the soil resistivity (ρ).

VII. Storing, clearing and checking the data

1. Data storage

When the testing is completed and valid data is displayed under the 2-wire/3-wire/4-wire/ ρ -wire mode, enter the data storage state by a long press on "SAVE" and save a group of testing data; at the data storage state, with a light press on "SAVE", save the second group of data, ... until the 20th group; when the memory is filled with data, with a light press on "SAVE", LCD will display "SAVE FULL" and the data cannot be saved unless some data are cleared. After another long press on "SAVE", exit the data storage state.

2. Data clearing

If want to clear the saved data, press "⌘" before starting up the instrument, the LCD will display "CL".

3. Check the saved data

Put the function selection switch at the gear RECALL, then you can check the first group of data saved and view other parameters in the group by pressing "DISP"; after pressing "▲", you can check the second, third ... group of data; or pressing "▼", check the 20th group data (when the memory is filled with data), 19th ... group data. LCD will display "--- RECALL ---" under the gear when no any group of data is saved in the memory.

VIII. Battery replacement

1. Set the range switch as OFF, and take off the testing wires from the instrument.
2. Screw out the battery cover screws inside the instrument, and replace the battery after taking off the cover. 8 cells should be replaced.
3. Put the battery cover in place after replacement and then tighten screws.

IX. Repair and maintenance

1. Cleaning the housing

Since diluted liquids such as the alcohol is corrosive to the housing, particularly the view window, dry towel should be used to slightly wipe the housing. Instrument should be kept from moisture.

2. Maintenance

Please contact with the after-sale service center of the marketing department or the agent in case of any following problems:

- A. Instrument housing or the part is damaged'
- B. Abnormal liquid crystal display;
- C. Abnormal data is detected during normal use;
- D. The key fails or gets into disorder;
- E. Noise occurs during testing.

UNI-T®

UT572 OPERATING MANUAL

UNI-T®

UT572 OPERATING MANUAL

The operating instruction is subject to change without any further notice.

UNI-T®
UNI-TREND TECHNOLOGY (CHINA) CO., LTD.
No6, Gong Ye Bei 1st Road,
Songshan Lake National High-Tech Industrial
Development Zone, Dongguan City,
Guangdong Province, China
Tel: (86-769) 8572 3888
<http://www.uni-trend.com>